

TANK REINFORCING 1000G, 1500G, & 2000G TANKS:

0' TO 2' BURY RESIDENTIAL

#3/40 @ 8" O.C. LONGITUDINAL & 12" O.C. TRANSVERSE @ TOP
#3/40 @ 12" O.C. EA. WAY @ BOTTOM

2'-1" TO 6' BURY RESIDENTIAL

0' TO 2' BURY NON-RESIDENTIAL

#4/60 @ 8" O.C. LONGITUDINAL & 12" O.C. TRANSVERSE @ TOP
#3/40 @ 8" O.C. EA. WAY or #4/40 @ 12" O.C. EA. WAY @ BOTTOM

2'-1" TO 6' BURY NON-RESIDENTIAL

#4/60 @ 8" O.C. EA. WAY @ TOP
#3/40 @ 8" O.C. EA. WAY or #4/40 @ 12" O.C. EA. WAY @ BOTTOM

TANK REINFORCING 2500G & 3500G TANKS:

0' TO 2' BURY RESIDENTIAL & NON-RESIDENTIAL

#4/60 @ 12" O.C. EA. WAY @ TOP & BOTTOM

2'-1" TO 6' BURY RESIDENTIAL & NON-RESIDENTIAL

#4/60 @ 8" O.C. EA. WAY @ TOP & BOTTOM

1 REINFORCING NOTES
R1 SCALE: N.T.S.

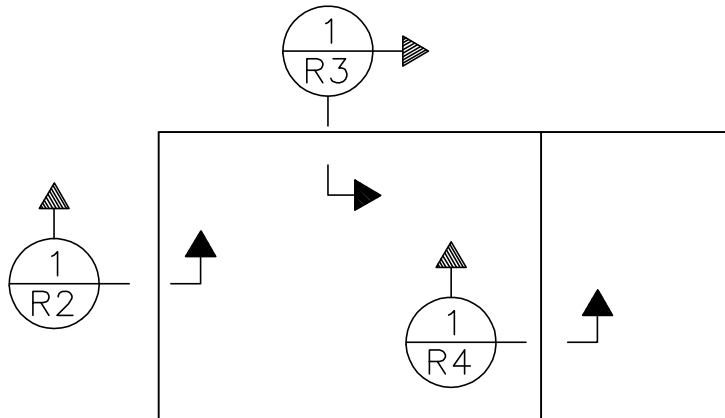

2 REINFORCING DETAIL KEY
R1 SCALE: N.T.S.

SHEET

R1

NON-TRAFFIC TANK REINF.

THREE FORKS LUMBER
THREE FORKS, MONTANA

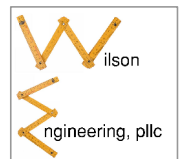

Three Forks, Montana
(406) 579-4758
www.wilsonengineer.com

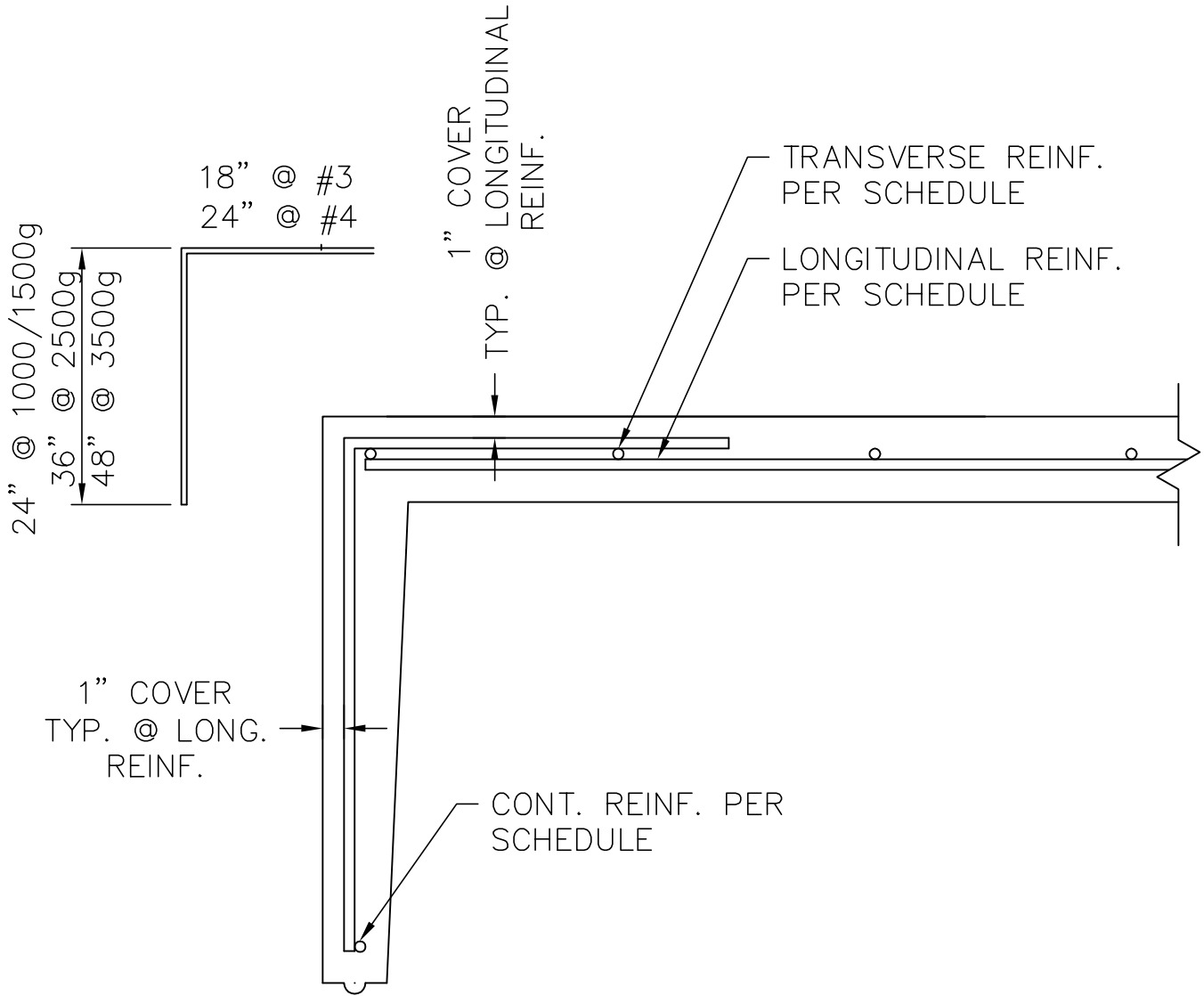

① LONGITUDINAL(LONG) TOP & BOTTOM REINF.
R2 SCALE 1 1/2"=1'-0"

SHEET

NON-TRAFFIC TANK REINF.

R2

THREE FORKS LUMBER
THREE FORKS, MONTANA

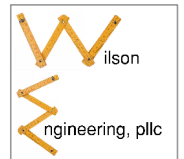

Three Forks, Montana
(406) 579-4758
www.wilsonengineer.com

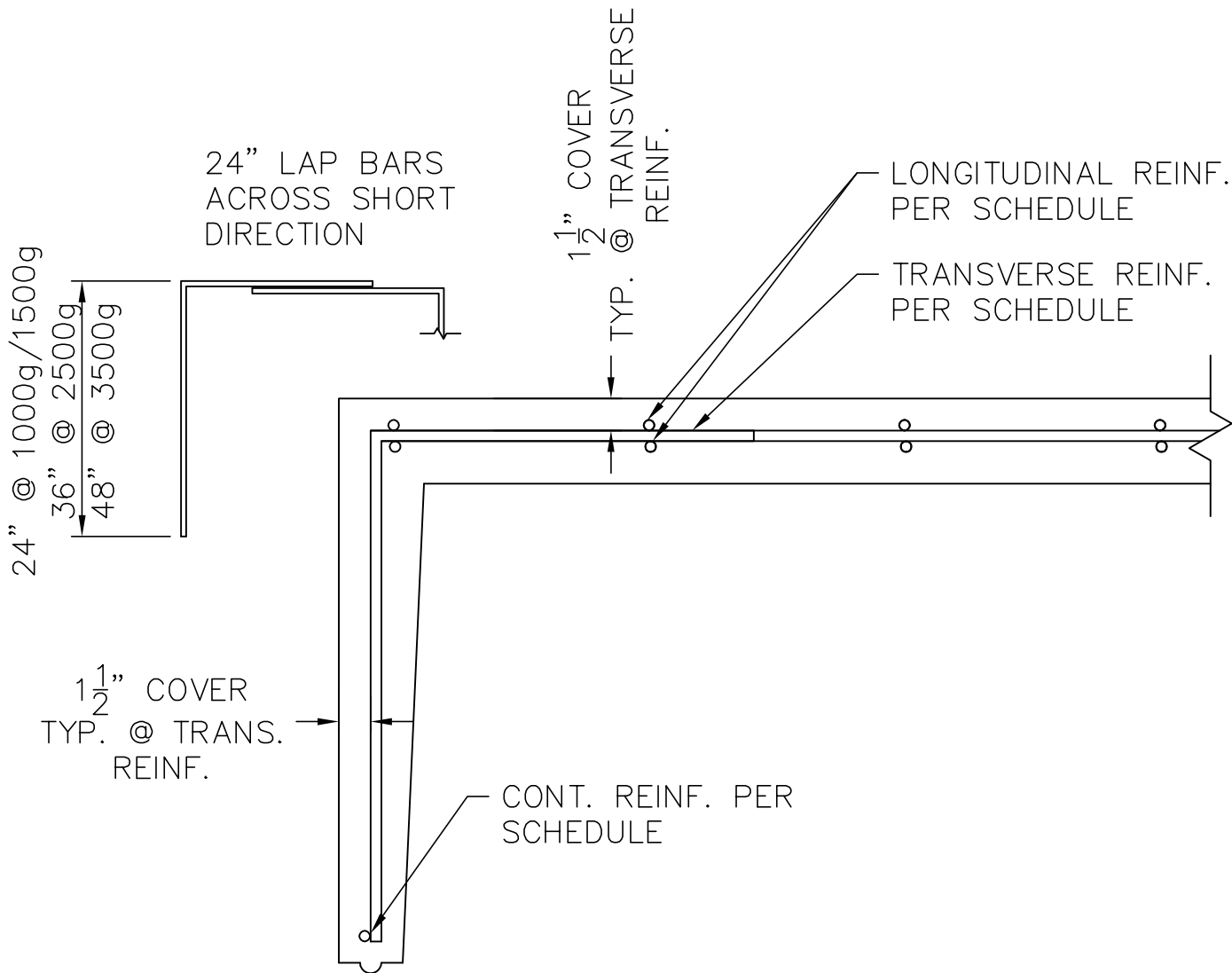

1 TRANSVERSE(SHORT) TOP & BOTTOM REINF.
R3 SCALE 1 1/2"=1'-0"

SHEET

NON-TRAFFIC TANK REINF.

R3

THREE FORKS LUMBER
THREE FORKS, MONTANA

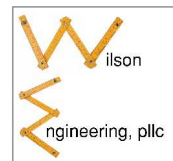

Three Forks, Montana
(406) 579-4758
www.wilsonengineer.com

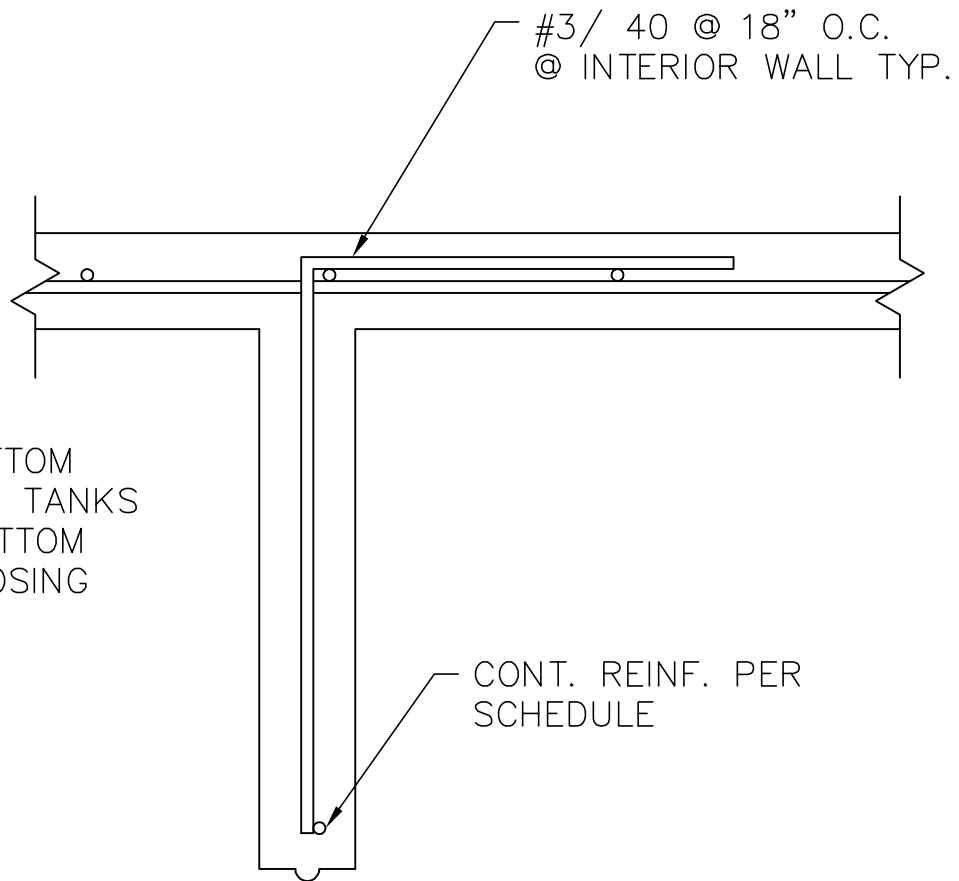

NOTE: REINF. BOTTOM
 INT. WALL AT ALL TANKS
 REINF. TOP & BOTTOM
 INT. WALLS AT DOSING
 TANKS ONLY

CONT. REINF. PER
 SCHEDULE

1 INTERIOR WALL REINF. TOP & BOTTOM
 R4 SCALE 1 1/2"=1'-0"

SHEET

NON-TRAFFIC TANK REINF.

R4

THREE FORKS LUMBER
 THREE FORKS, MONTANA

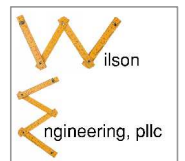

Three Forks, Montana
 (406) 579-4758
 www.wilsonengineer.com